



SUBARU

Industrial Power Products

PKX series

201/301/401 201H
201ST/301ST 201T/301T/401T
210/310 220/320 220ST/320ST

- (US)** *INSTRUCTIONS FOR USE*
- (FR)** *MANUEL D'UTILISATION*
- (ES)** *MANUAL DE INSTRUCCIONES*

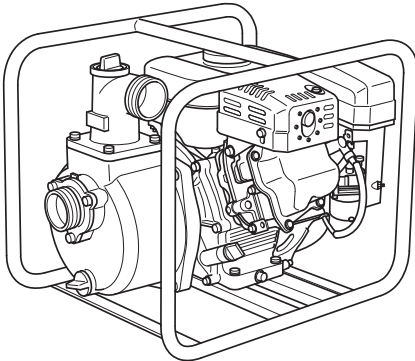

9ZZ9990124

北美

SUBARU Pump

1

PKX201,301,401, 201H,
201ST, 301ST, 220ST, 320ST,
210, 310, 220, 320

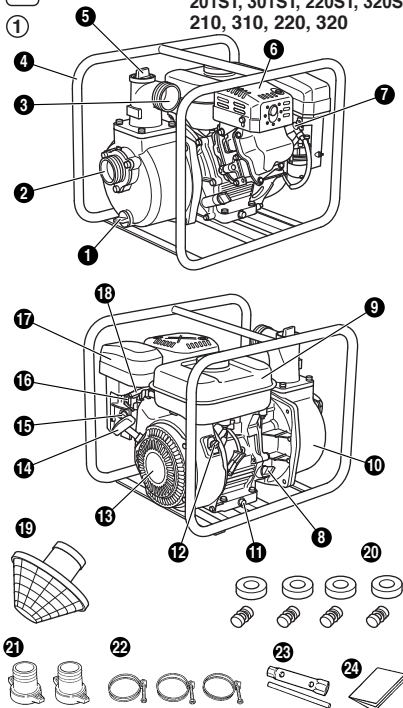

PKX201T, 301T, 401T

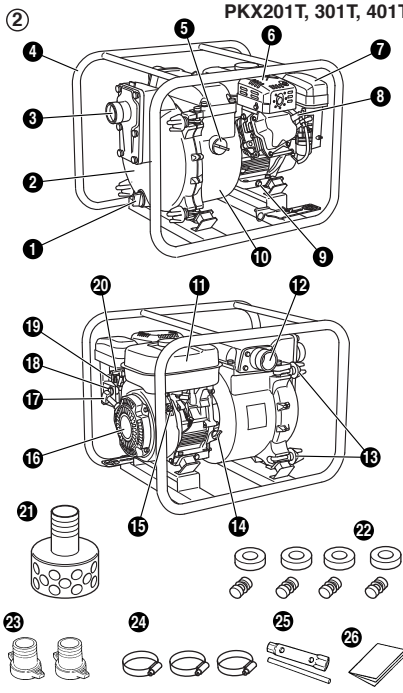

2

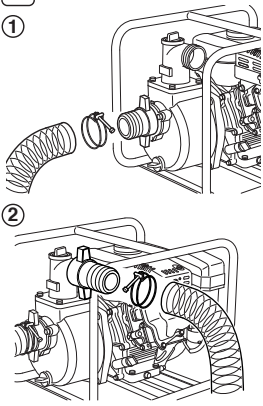

3

	[5W]								
		10W							
Single grade			20W	#20		#30		#40	
					10W-30		10W-40		
Multi grade									
Ambient temperature:	-20	-10	0	10	20	30	40 °C		
	-4	14	32	50	68	86	104 °F		

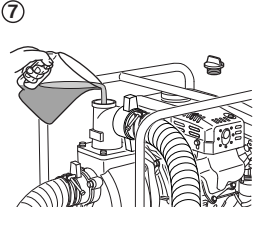
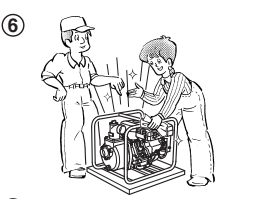
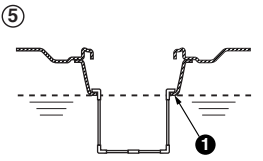
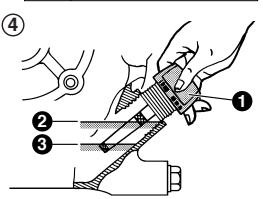

3

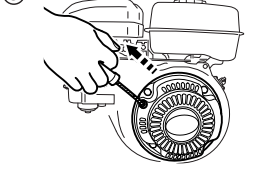
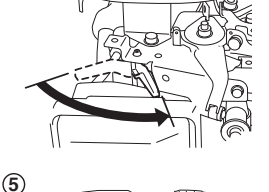
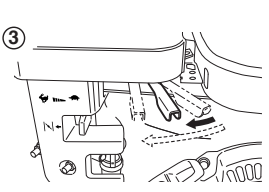
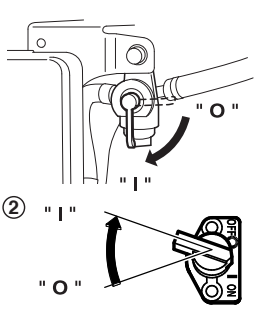
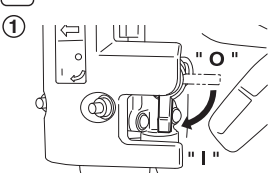

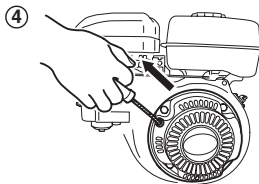
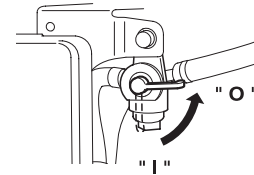
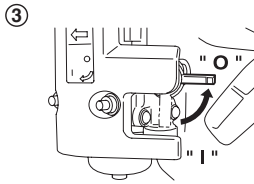
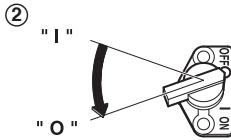
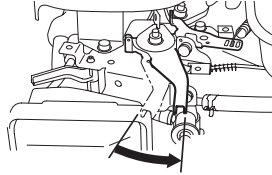
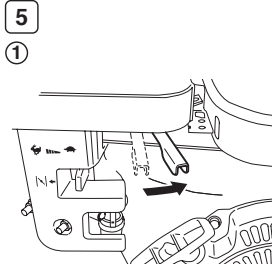
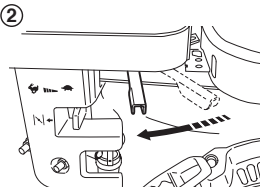
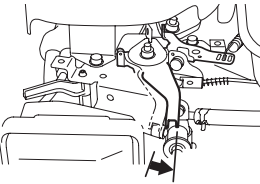
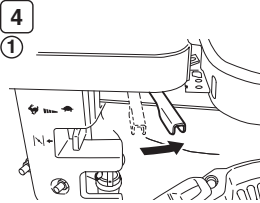
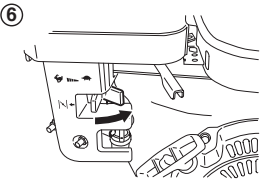

6 PKX201,301,401, 201H,
201ST, 301ST, 220ST, 320ST,
210, 310, 220, 320

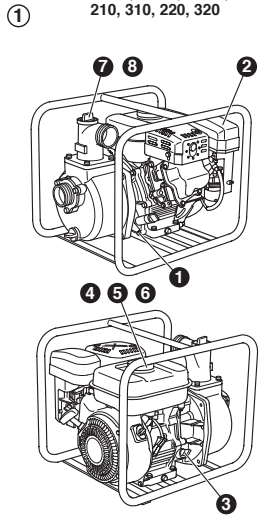

2 PKX201T, 301T, 401T

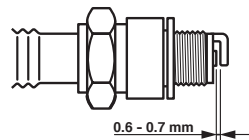
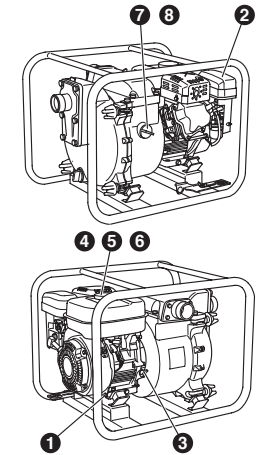

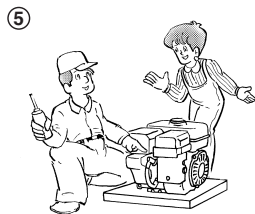
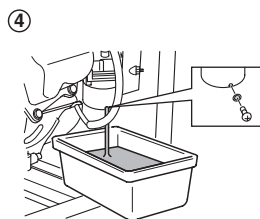
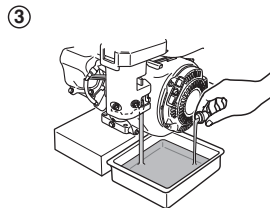
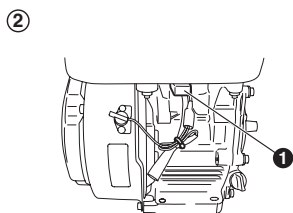
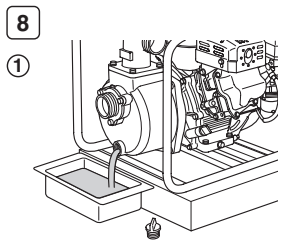
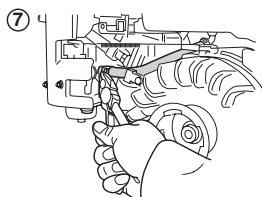
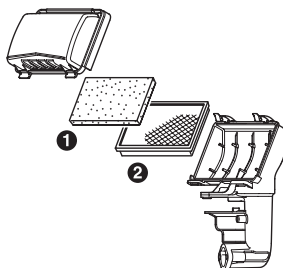
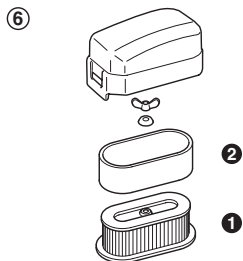
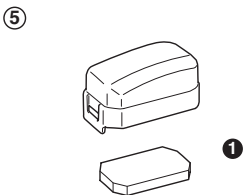
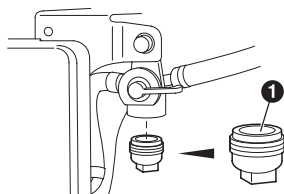
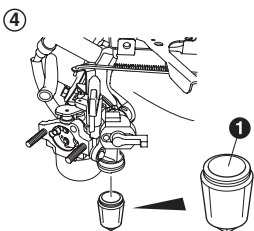
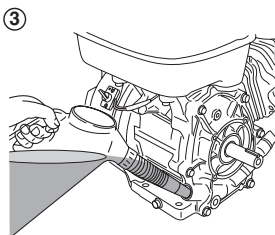
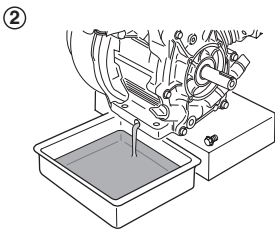

NOTICE

FEDERAL EMISSION COMPONENT DEFECT WARRANTY and CALIFORNIA EMISSION CONTROL WARRANTY are applicable to only those engines/generators complied with EPA (Environmental Protection Agency) and CARB (California Air Resources Board) emission regulations in the U.S.A.

NOTICE

To the engines/generators exported to and used in the countries other than the U.S.A., warranty service shall be performed by the distributor in each country in accordance with the standard SUBARU engine/generator warranty policy as applicable.

FOREWORD

Thank you very much for purchasing a **SUBARU PUMP**.

This manual covers operation and maintenance of **SUBARU PUMP**.

All information in this publication is based on the latest product information available at the time of approval for printing. Please read this manual carefully before operating.

Please take a moment to familiarize yourself with the proper operation and maintenance procedures in order to maximize the safe and efficient use of this product.

Keep this owner's manual at hand, so that you can refer to it at any time.

Due to constant efforts to improve our products, certain procedures and specifications are subjected to change without notice.

When ordering spare parts, always give us the **MODEL, PRODUCTION NUMBER and SERIAL NUMBER** of your pump.

Please fill in the following blanks after checking the production number on your pump.

(Location of label is different depending on the pump specification.)

PROD No.	SER No.

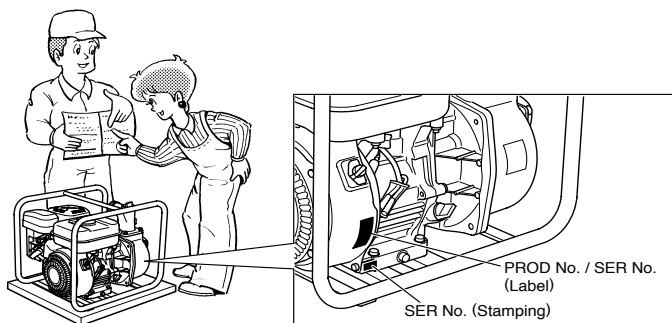

CONTENTS

	Page
1. SAFETY PRECAUTIONS	2
2. COMPONENTS	5
3. PRE-OPERATION FOR STARTING	6
4. OPERATING YOUR PUMP	7
5. MAINTENANCE	7
6. PREPARATIONS FOR STORAGE	10
7. OIL SENSOR INSTRUCTIONS	10
8. SPARK ARRESTER (OPTIONAL)	10
9. EASY TROUBLESHOOTING	11
10. SPECIFICATIONS	12

NOTE Please refer to the illustrations on the back page of the front cover or back cover for Fig. ① to ⑧ indicated in the sentence.

1. SAFETY PRECAUTIONS

Please make sure you review each precaution carefully.

Pay special attention to statement preceded by the following words.

⚠ WARNING “WARNING” indicates a strong possibility of severe personal injury or loss of life if instructions are not followed.

⚠ CAUTION “CAUTION” indicates a possibility of personal injury or equipment damage if instructions are not followed.

⚠ WARNING : EXHAUST PRECAUTIONS

- Never inhale exhaust gasses.
They contain carbon monoxide, a colorless, odorless and extremely dangerous gas which can cause unconsciousness or death.
- Never operate the pump indoors or in a poorly ventilated area, such as tunnel, cave, etc.
- Exercise extreme care when operating the pump near people or animals.
- Keep the exhaust pipe free of foreign objects.

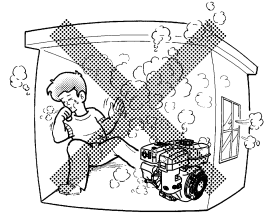

⚠ WARNING : REFUELING PRECAUTIONS

- Gasoline is extremely flammable and its vapors can explode if ignited.
- Do not refuel indoors or in a poorly ventilated area.
- Be sure to stop the pump prior to refueling.
- Do not remove fuel tank cap nor fill fuel tank while engine is hot or running.
Allow engine to cool at least 2 minutes before refueling.
- Do not overfill the fuel tank.
- If fuel is spilt, wipe it away carefully and wait until the fuel has dried before starting the engine.
- After refueling, make sure that the fuel cap is secured to prevent spillage.

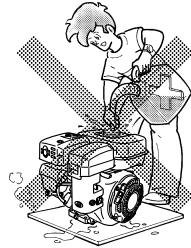

⚠ WARNING : FIRE PREVENTION

- Do not operate the pump while smoking or near an open flame.
- Do not use around dry brush, twigs, cloth rags, or other flammable materials.
- Keep cooling air intake (recoil starter area) and muffler side of the engine at least 1 meter (3 feet) away from buildings, obstructions and other burnable objects.
- Keep the pump away from flammables and other hazardous materials (trash, rags, lubricants, explosives).

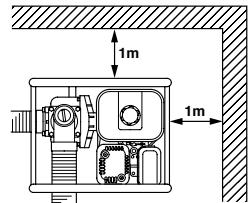

⚠ WARNING : OTHER SAFETY PRECAUTIONS

- Be careful of hot parts.
The muffler and other engine parts become very hot while the pump is running or just after it has stopped. Operate the pump in a safe area and keep children away from the running pump.
- Do not use diaphragm pump for the mixture of water and oil.
- Do not touch the spark plug and ignition cable when starting and operating the engine.

- Operate the pump on a stable, level surface.
If the engine is tilted, fuel spillage may result.

NOTE

Operating the pump at a steep incline may cause seizure due to improper lubrication even with a maximum oil level.

- Do not transport the pump with fuel in tank or with fuel strainer valve open.
- Keep the unit dry (do not operate it in rainy conditions).

CAUTION : PRE-OPERATION CHECKS

- Carefully check fuel hoses and joints for looseness and fuel leakage. Leaked fuel creates a potentially dangerous situation.
- Check bolts and nuts for looseness. A loose bolt or nut may cause serious engine trouble.
- Check the engine oil and refill if necessary.
- Check the fuel level and refill if necessary. Take care not to overfill the tank.
- Keep cylinder fins and recoil starter free of dirt, grass and other debris.
- Wear snug fitting working clothes when operating the engine.
Loose aprons, towels, belt, etc., may be caught in the engine or drive train, causing a dangerous situation.

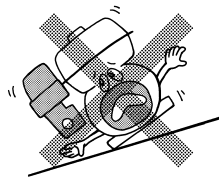

CAUTION : BEWARE OF WATER-HAMMERING

- Do not allow the delivery hose to be trampled over by a vehicle's wheel, or do not close the delivery valve abruptly otherwise a water-hammer occurs which may result heavy damage to the pump.

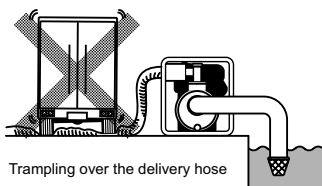

Trampling over the delivery hose

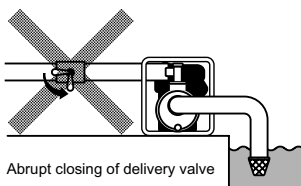

Abrupt closing of delivery valve

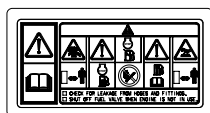

CAUTION : PRECAUTIONS ON THE HANDLING OF THE WARNING LABEL

- Warning labels are affixed to our engines with regard to particularly serious dangers. When using the engines, please use them safely after carefully reading the instruction manual and understanding the dangers.

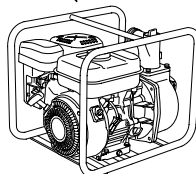

Warning Label Exclusively for the United States and Canada

WARNING	
<p>Read INSTRUCTIONS FOR USE before use.</p> <p>The engine emits toxic gas can kill you in minutes. Do not run in an enclosed area. Hot surface can burn you. Stay away if engine has been running.</p>	<p>Gasoline is extremely flammable and its vapors can explode.</p> <p>• Stop the engine before refueling.</p> <p>• Check for leakage from hoses and fittings.</p> <p>• Shut off fuel valve when the engine is not in use.</p>

AVERTISSEMENT	
<p>Lire les INSTRUCTIONS POUR L'USAGE avant d'utiliser le moteur.</p> <p>Le moteur émet un gaz toxique qui peut vous tuer en quelques minutes. Ne pas utiliser le moteur dans un emplacement fermé.</p> <p>La surface chaude peut vous brûler. Éloignez du moteur s'il est en marche.</p>	<p>L'essence est extrêmement inflammable et ses vapeurs peuvent exploser.</p> <p>• Arrêter le moteur avant de faire le plein ou combuster.</p> <p>• Vérifier toute présence de fuite à partir des tuyaux et des joints.</p> <p>• Éloigner la source de carburant quand le moteur n'est pas utilisé.</p>

ADVERTENCIA	
<p>Leer las INSTRUCCIONES PARA EL USO antes de utilizar el motor.</p> <p>El motor emite un gas tóxico que puede matar al operador en algunas minutos. No utilizar el motor en un sitio cerrado.</p> <p>La superficie caliente puede quemar. Alejarse del motor si se encuentra en marcha.</p>	<p>La gasolina es extremadamente inflamable y sus vapores pueden explotar.</p> <p>• Detener el motor antes de hacer el llenado o combustible.</p> <p>• Comprobar si hay presencia de fuga de partes los tubos y juntas.</p> <p>• Evitar la fuente de combustible cuando no se utiliza el motor.</p>

For use in the United States or Canada, please affix the label suited to the region from among the enclosed warning labels.

SYMBOLS

	<i>Read manual.</i>		<i>Shut off fuel valve when the engine is not in use.</i>
	<i>Stay clear of the hot surface.</i>		<i>Check for leakage from hose and fittings.</i>
	<i>Exhaust gas is poisonous. Do not operate in an unventilated room or enclosed area.</i>		<i>Fire, open flame and smoking prohibited.</i>
	<i>Stop the engine before refueling.</i>		<i>HOT, avoid touching the hot area.</i>

USA and CANADA only

	Read INSTRUCTIONS FOR USE before use.		The engine emits toxic gas can kill you in minutes. Do not run in an enclosed area.		Hot surface can burn you. Stay away if engine has been running.
	Gasoline is extremely flammable and its vapors can explode. <ul style="list-style-type: none"> • Stop the engine before refueling. • Check for leakage from hoses and fittings. • Shut off fuel valve when the engine is not in use. 				

	On (Run)		Engine start (Electric start)		Fuel (gasoline)		Primer
○	Off (Stop)		Engine stop		Fuel (diesel)		Push primer
	Engine oil		Cold engine		Fuel shut-off		Do not push primer
	Add oil		Warm engine		Fuel system failure / malfunction	2X	Two times
	Battery		Electrical preheat (Low temperature start aid)		Choke		
	Fast		Run position	+	Plus ; positive polarity		
	Slow		Stop position	-	Minus ; negative polarity		

2. COMPONENTS

(See Fig. ①)

NOTE Please refer to the illustrations on the back page of the front cover or back cover for Fig. ① to ⑧ indicated in the sentence.

CENTRIFUGAL PUMP (PKX201, 301, 401, 201H, 210, 310, 220, 320)

SEMI TRASH PUMP (PKX201ST, 301ST, 220ST, 320ST)

(See Fig. ①-①)

- | | | |
|-------------------------------|------------------------------|---|
| ① Plug (drain) | ⑩ Casing cover | ⑲ Strainer |
| ② Suction | ⑪ Drain plug (at two places) | ⑳ Cushion rubber |
| ③ Delivery | ⑫ Stop Switch | ㉑ Hose coupling *1 |
| ④ Frame | ⑬ Recoil starter | ㉒ Hose band |
| ⑤ Plug (priming) | ⑭ Recoil Starter handle | ㉓ Tools |
| ⑥ Muffler | ⑮ Fuel valve | ㉔ Instruction for use
(This publication) |
| ⑦ Spark plug | ⑯ Chocke lever | |
| ⑧ Oil filler (with oil guage) | ⑰ Air cleaner | |
| ⑨ Fuel tank | ⑱ Speed control lever | |

*1 Except PKX220, 320, 220ST, 320ST

TRASH PUMP (PKX201T, 301T, 401T)

(See Fig. ①-②)

- | | | |
|------------------------------|-------------------------------|---|
| ① Plug (drain) | ⑪ Fuel tank | ㉑ Strainer |
| ② Casing | ⑫ Delivery | ㉒ Cushion rubber |
| ③ Suction | ⑬ Knob | ㉓ Hose coupling |
| ④ Frame | ⑭ Oil filler (with oil guage) | ㉔ Hose band |
| ⑤ Plug (priming) | ⑮ Stop switch | ㉕ Tools |
| ⑥ Muffler | ⑯ Recoil Starter | ㉖ Instruction for use
(This publication) |
| ⑦ Air cleaner | ⑰ Recoil Starter handle | |
| ⑧ Spark plug | ⑱ Fuel valve | |
| ⑨ Drain plug (at two places) | ⑲ Chocke lever | |
| ⑩ Casing cover | ⑳ Speed control lever | |

3. PRE-OPERATION FOR STARTING

(See Fig. ②)

1. CONNECT SUCTION HOSE

(See Fig. ②-①)

Use a reinforced-wall or wire braided hose to prevent suction collapse.

Since the pump self-priming time is directly proportional to hose length, a short hose is recommended.

⚠ CAUTION

Always use a strainer with the suction hose. Gravel or debris sucked into the pump will cause serious damage to the impeller and the pump casting.

2. CONNECT DELIVERY HOSE

(See Fig. ②-②)

When using a fabric hose, always use a hose band to prevent the hose from disconnecting under high pressure.

3. CHECK ENGINE OIL (See Fig. ②-④)

Before checking or refilling engine oil, be sure the engine is located on stable, level surface and stopped.

- Do not screw the oil gauge into the oil filler neck to check oil level. If the oil level is low, refill to the upper level with the following recommended oil.
- Use 4-stroke automotive detergent oil of API service class SE or higher grade (SG, SH or SJ is recommended).
- Select the viscosity based on the air temperature at the time of operation as shown in the table. (See Fig. ②-③)

Explanation of Fig. ②-④

- ① Oil Gauge
- ② Upper Level
- ③ Lower Level

Model	Oil capacity Liter (U.S. gal)
PKX201, PKX301, PKX201H, PKX201ST, PKX301ST, PKX201T, PKX210, PKX310 PKX220, PKX320, PKX220ST, PKX320ST	0.6 (0.16)
PKX401, PKX301T	1.1 (0.29)
PKX401T	1.2 (0.32)

4. CHECK FUEL (See Fig. ②-⑤)

⚠ WARNING

Do not refuel while smoking, near an open flame or other such potential fire hazards. Otherwise fire accident may occur.

NOTE

THIS ENGINE IS CERTIFIED TO OPERATE ON AUTOMOTIVE UNLEADED GASOLINE.

- Stop the engine and open the cap.
- Use unleaded automotive gasoline only.
 - Unleaded regular/premium or reformulated gasoline containing no more than 10% Ethanol (E10), or 15% MTBE may also be used.
 - Never use gasoline containing ethanol exceeding 10%, or MTBE exceeding 15% because engine or fuel system damage could result.
 - Never use stale or contaminated gasoline.
 - Use of these non-recommended fuels may result in reduced performance and/or denial of warranty.

Fuel Tank Capacity

Refer to "10. SPECIFICATIONS" Page 12 or 13 for fuel tank capacity

- Close the fuel valve before filling the fuel tank.

Explanation of Fig. ③-①

- ① Maximum Fuel level
- Do not fill above the top of the fuel filter screen (marked ①), or the fuel may overflow when it heats up later and expands.
- When filling the fuel tank, always use the fuel filter screen.
- Reattach the fuel cap by turning clockwise until reaching the physical stop (about one quarter turn). Do not attempt to turn past the physical stop or the fuel cap may be damaged.
- Wipe off any spilled fuel before starting the engine. (See Fig. ②-⑥)

5. CHECK PRIMING WATER

(See Fig. ②-⑦)

It is recommended that the water chamber of pump casing should be primed with full of water before operating.

⚠ WARNING

Never attempt to operate the pump without priming water or the pump will overheat. Extended dry operation will destroy the mechanical seal.

If the unit has been operated dry, stop the engine immediately and allow the pump to cool before adding priming water.

4. OPERATING YOUR PUMP

1. STARTING (See Fig. ③)

- (1) Open the fuel valve. (See Fig.③-①)
- (2) Turn the STOP SWITCH to the position " I " (ON). (See Fig.③-②)
- (3) Set the speed control lever 1/3 of the way towards the high speed position. (See Fig.③-③)
- (4) Close the choke lever. (See Fig.③-④)
 - If the engine is cold or the ambient temperature is low, close the choke lever fully.
 - If the engine is warm or the ambient temperature is high, open the choke lever half-way, or keep it fully open.
- (5) Pull the starter handle slowly until resistance is felt. This is the "compression" point. Return the handle to its original position and pull swiftly. Do not pull out the rope all the way. After starting the engine, allow the starter handle to return to its original position while still holding the handle. (See Fig.③-⑤)
- (6) After starting the engine, gradually open choke by turning the choke lever and finally keep it fully opened. Do not fully open the choke lever immediately when the engine is cold or the ambient temperature is low, because the engine may stop. (See Fig.③-⑥)

2. RUNNING (See Fig. ④)

- (1) After the engine starts, set the speed control lever at the low speed position (L) and warm it up without load for a few minutes. (See Fig.④-①)
- (2) Gradually move the speed control lever toward the high speed position (H) and set it at the required engine speed. (See Fig.④-②)
 - Whenever high speed operation is not required, slow the engine down (idle) by moving the speed control lever to save fuel and extend engine life.

3. STOPPING (See Fig. ⑤)

- (1) Set the speed control lever at the low speed position and allow the engine to run at low speed for 1 or 2 minutes before stopping. (See Fig.⑤-①)
- (2) Turn the STOP SWITCH counterclockwise to the position " O " (OFF). (See Fig.⑤-②)
- (3) Close the fuel valve. (See Fig.⑤-③)
- (4) Pull the starter handle slowly and return the handle to its original position when resistance is felt. This operation is necessary to prevent outside moist air from intruding into the combustion chamber. (See Fig.⑤-④)

※ STOPPING ENGINE WITH THE FUEL VALVE

Close the fuel valve and wait for a while until the engine stops. Avoid to let the fuel remain in the carburetor over long periods, or the passages of the carburetor may become clogged with impurities, and malfunctions may result.

5. MAINTENANCE

(See Fig. ⑥)

MAINTENANCE, REPLACEMENT, OR REPAIR OF THE EMISSION CONTROL DEVICES AND SYSTEMS MAY BE PERFORMED BY ANY NONROAD ENGINE REPAIR ESTABLISHMENT OR INDIVIDUAL.

1. DAILY INSPECTION

Before running the engine, check the following service items.

- ① Loose or broken bolts and nuts
- ② Clean air cleaner element
- ③ Enough clean engine oil
- ④ Leakage of gasoline and engine oil
- ⑤ Enough gasoline
- ⑥ Safe surroundings
- ⑦ Check the priming water
- ⑧ Excessive vibration, noise

2. PERIODIC INSPECTION

Periodic maintenance is vital to the safe and efficient operation of your pump.

Check the table below for periodic maintenance intervals.

IT IS ALSO NECESSARY FOR THE USER OF THIS PUMP TO CONDUCT THE MAINTENANCE AND ADJUSTMENTS ON THE EMISSION-RELATED PARTS LISTED BELOW TO KEEP THE EMISSION CONTROL SYSTEM EFFECTIVE.

The emission control system consists of the following parts :

- (1) Carburetor and internal parts
- (2) Cold start enrichment system, if applicable
- (3) Intake manifold, if applicable
- (4) Air cleaner elements
- (5) Spark plug
- (6) Magneto or electronic ignition system
- (7) Spark advance/ retard system, if applicable
- (8) Exhaust manifold, if applicable.
- (9) Hoses, belts, connectors, and assemblies

The maintenance schedule indicated in the following table is based on the normal engine operation.

Should the engine be operated in extremely dusty condition or in heavier loading condition, the maintenance intervals must be shortened depending on the contamination of oil, clogging of filter elements, wear of parts, and so on.

Periodic Maintenance Schedule table

Maintenance Items	Every 8 hours (Daily)	Every 50 hours (Weekly)	Every 200 hours (Monthly)	Every 500 hours	Every 1000 hours
Clean pump set and check bolt and nuts	● (Daily)				
Check for leakage from hoses and fitting	● (Daily)				
Check and refill engine oil	● (Refill daily up to upper level)				
Change engine oil (*Note 1)	● (Initial 20 hours)	● (Every 100 hours)			
Clean spark plug		● (Every 100 hours)			
Clean air cleaner		●			
Clean spark arrester (Optional part)		● (Every 100 hours)			
Replace air cleaner element			●		
Clean fuel cup			●		
Clean and adjust spark plug and electrodes			●		
Replace spark plug				●	
Remove carbon from cylinder head (*Note 2)				●	
Check and adjust valve clearance (*Note 2)				●	
Clean and adjust carburetor (*Note 2)				●	
Replace fuel lines					● (Every 2 years)
Overhaul engine if necessary (*Note 2)					●

*Note 1: Initial oil change should be performed after first twenty (20) hours of operation. Thereafter change oil every hundred (100) hours. Before changing oil, check for a suitable way to dispose of old oil. Do not pour it down into sewage drains, onto garden soil or into open streams. Your local zoning or environmental regulations will give you more detailed instructions on proper disposal.

*Note 2: As to the procedures for these items, please refer to the SERVICE MANUAL or consult your nearest service dealer.

⚠ CAUTION

Replace rubber pipes for fuel passage every two years. If fuel leakage is found, replace the pipe immediately.

3. INSPECTING THE SPARK PLUG

(See Fig. 7-①)

- (1) Clean off carbon deposits on the spark plug electrode using a plug cleaner or wire brush.
- (2) Check electrode gap. The gap should be 0.6 mm to 0.7 mm (0.02 inch. - 0.03 inch.). Adjust the gap, if necessary, by carefully bending the side electrode.

Model	Recommended Spark Plug
PKX201, PKX301, PKX401 PKX201H PKX201ST, PKX301ST PKX201T, PKX301T, PKX401T	NGK BR-6HS
PKX210, PKX310 PKX220, PKX320 PKX220ST, PKX320ST	TORCH E6RC

4. ENGINE OIL CHANGE (See Fig. 7-②,③)

Initial oil change : After 20 hours of operation
Thereafter : Every 100 hours of operation

- (1) When changing oil, stop the engine and loosen the drain plug. Drain the used oil while the engine is warm. Warm oil drains quickly and completely.

⚠ CAUTION

To prevent injury, pay attention to the hot oil. Make sure the fuel cap is tightly secured to avoid spillage.

- (2) Re-install the drain plug before refilling oil.

Model	Oil capacity Liter (U.S. gal)
PKX201, PKX301, PKX201H, PKX201ST, PKX301ST, PKX201T, PKX210, PKX310 PKX220, PKX320, PKX220ST, PKX320ST	0.6 (0.16)
PKX401, PKX301T	1.1 (0.29)
PKX401T	1.2 (0.32)

- (3) Refer to page 6 for the recommended oil.
- Always use the best grade and clean oil. Contaminated oil, poor quality oil and shortage of oil cause damage to engine or shorten the engine life.

5. CLEANING FUEL CUP (See Fig. 7-4)**⚠ WARNING Flame Prohibited**

- Inspect fuel cup for water and dirt.
(See Fig. 7-4-1)
- To remove water and dirt, close the fuel valve and remove the fuel cup.
- After removing dirt and water, wash the fuel cup with kerosene or gasoline. Reinstall securely to prevent leakage.

**6. CLEANING AIR CLEANER
(See Fig. 7-5, 6)**

A dirty air cleaner element will cause starting difficulty, power loss, engine malfunctions, and shorten engine life extremely. Always keep the air cleaner element clean.

⚠ WARNING Flame Prohibited

- Urethane Foam Element Type
(See Fig. 7-5)
Remove the element and wash it in washing oil (kerosene). Then saturate it in engine oil and squeeze it firmly before installing. (See Fig. 7-5-1)
- Urethane Foam Dual Element Type
(See Fig. 7-6)
 - For EX13/16/17 urethane foam, remove it from the paper element and wash it in washing oil (kerosene). Then saturate it in engine oil and squeeze it firmly before installing. (See Fig. 7-6-2)

- For EX27/40 urethane foam, remove it from the paper element and wash it thoroughly with detergent. Then dry it before installing. (See Fig. 7-6-2)
- For the paper element, clean by blowing on it with compressed air from the inside or tapping on it gently to remove dirt. Change the paper element when doing this fails to remove the dirt.
(See Fig. 7-6-1)

Clean and replace air cleaner elements more often when operating in dusty environments.

7. FUEL HOSE REPLACEMENT (See Fig. 7-7)**⚠ WARNING**

Take extreme caution when replacing fuel hose ; gasoline is extremely flammable.

Replace the fuel hose every 1,000 hours or every 2 years. If fuel leaks from fuel hose, replace the fuel hose immediately.

8. CHECKING BOLTS, NUTS AND SCREWS

- Retighten loose bolts and nuts.
- Check for fuel and oil leaks.
- Replace damaged parts with new ones.

9. CLEANING PUMP INSIDE

- Turn the knob counterclockwise and open the casing cover holder.
- Pull the casing toward you, and then remove the casing and the inner casing.
- Clean the inside of pump casing and casing cover with clean water.

10. HIGH ALTITUDE ENGINE OPERATION

- Please have an authorized SUBARU Industrial Power Products dealer modify this engine if it is to be run continuously above 5000 feet (1500 meters). Failure to do so, may result in poor engine performance, spark plug fouling, hard starting, and increased emissions.
- Carburetor modification by an authorized SUBARU Industrial Power Products dealer will improve performance and allow that this engine meets EPA (Environmental Protection Agency) and California ARB (Air Resources Board) emission standards throughout its useful life.
- An engine converted for high altitudes can not be run at 5000 feet or lower. In doing so, the engine will overheat and cause serious engine damage. Please have an authorized SUBARU Industrial Power Products dealer restore high altitude modified engines to the original factory specification before operating below 5000 feet.

6. PREPARATIONS FOR STORAGE

1. WATER (See Fig. 8-1)

Drain all water from the drain plug.

⚠ CAUTION

When retightening drain plug, be sure to clean the drain plug and the thread of casing. Otherwise, the thread may be damaged.

2. DISCONNECT THE DELIVERY HOSE

Tilt the pump and drain all water from delivery hole. Severe damage to pump may result if water freezes in the pumping chamber.

3. DISCHARGE FUEL (See Fig. 8-3 thru 4)

⚠ WARNING Flame Prohibited

If you do not use the engine more than 1 month, discharge fuel to prevent gum in the fuel system and carburetor parts.

- Remove the strainer cup, place the strainer over a container and open the strainer valve to discharge fuel from the fuel tank. (See Fig. 8-3)
- Remove the drain screw of the carburetor float chamber and discharge fuel. (See Fig. 8-4)

4. ENGINE OIL (See Fig. 8-5)

- Change the engine oil with fresh oil.
- Remove the spark plug, pour about 5 cc of engine oil into the cylinder, slowly pull the starter handle of the recoil starter 2 or 3 times, and reinstall the spark plug.

5. CLEAN AND STORE

- Slowly pull the recoil starter handle until resistance is felt and leave it in that position.
- Clean the pump thoroughly with an oiled cloth, put the cover on, and store the pump indoors in a well ventilated, low humidity area.

7. OIL SENSOR INSTRUCTIONS

(OPTIONAL)

1. FUNCTION OF OIL SENSOR

The engine will stop automatically when the oil level falls below the safety limit. The engine cannot be started unless the level is raised above the prescribed limit.

(See Fig. 2-4)

2. RESTARTING

- (1) Fill the crankcase with oil up to the proper level.
- (2) As for restarting and operating the engine, refer to section "4. OPERATING YOUR PUMP" on page 7.
 - Check the wire connector from the engine. It must be connected securely to the wire from oil sensor.
 - When selecting the engine oil, refer to page 6 for the recommended oil.

8. SPARK ARRESTER (OPTIONAL)

1. SPARK ARRESTER

In a dry or wooded area, it is recommendable to use the product with a spark arrester. Some areas require the use of a spark arrester. Please check your local laws and regulations before operating your product.

The spark arrester must be cleaned regularly to keep it functioning as designed. A clogged spark arrester:

- Prevents the flow of exhaust gas
- Reduces engine output
- Increases fuel consumption
- Makes starting difficult

⚠ CAUTION

If the engine has been running, the muffler and the spark arrester will be very hot. Allow the muffler to cool before cleaning the spark arrester.

How to remove the spark arrester

1. Remove the flange bolts from the muffler cover and remove the muffler cover.
2. Remove the special screw from the spark arrester and remove the spark arrester from the muffler.

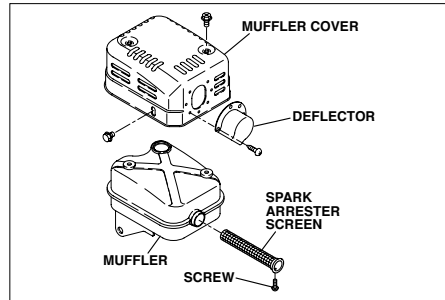

Clean the spark arrester screen

Use a brush to remove carbon deposits from the spark arrester screen. Be careful to avoid damaging the screen. The spark arrester must be free of breaks and holes. Replace the spark arrester if it is damaged.

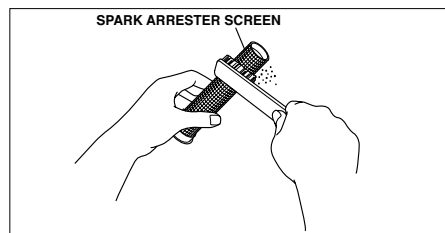

Install the spark arrester, and muffler protector in the reverse order of disassembly.

9. EASY TROUBLESHOOTING

1. PUMP DOES NOT RUN .

- Engine dose not start.
(See 9.-4 "4. WHEN ENGINE DOES NOT START")
- Sticking of impeller
(Disassemble and clean.)

2. PUMPING VOLUME IS SMALL.

- Sucking air at suction side.
(Check piping at suction side.)
- Drop off engine output
(Consult your nearest dealer.)
- Breakage of mechanical seal.
(Consult your nearest dealer.)
- High suction lift (Lower.)
- Suction hose is too long or thin.
(Use a thick hose in minimum length.)
- Leak of water from water passage.
(Stop leaking.)
- Clogging of foreign substance in impeller.
(Disassemble and clean.)
- Wear of impeller.
- Looseness of suction chamber. (Retighten)
- Strainer is clogged. (Clean.)
- Engine speed is too low.
(Consult your nearest dealer.)

3. PUMP DOES NOT SELFPRIME.

- Suction of air at suction side.
(Check piping at suction side.)
- Insufficient priming water inside pump casing
(Prime fully.)
- Imperfect tightening of drain plug.
(Tighten the plugs completely.)
- Engine speed is too low.
(Consult your nearest dealer.)
- Sucking air from mechanical seal.
(Consult your nearest dealer.)

4. WHEN ENGINE DOES NOT START :

Perform the following checks before you take the pump to your SUBARU Industrial Power Products dealer. If you still have trouble after completing the checks, take the pump to your nearest SUBARU Industrial Power Products dealer.

(1) Is there a strong spark across the electrode ?

- Is the stop switch at position " I " (ON)?
- Remove and inspect the spark plug.
If the electrode is fouled, clean or replace it with new one.
- Remove the spark plug and connect it to the plug cap.
Pull the starter handle while grounding spark plug against engine body. Try with a new spark plug if the spark is weak or there is no spark.
The ignition system is faulty if there is no spark with a new spark plug.

WARNING

- **Wipe out spilled fuel carefully before testing. Place spark plug as far away from spark plug hole as possible.**
- **Do not hold spark plug by hand while pulling recoil starter.**

NOTE

The engine with oil sensor will stop automatically when the oil level falls below the prescribed limit. Unless the oil level is raised above the prescribed limit, the engine will stop immediately after starting.

(2) Is there enough compression?

Pull the starter handle slowly and check if resistance is felt. If little force is required to pull the starter handle, check if the spark plug is tightened firmly. If the spark plug is loose, tighten it.

(3) Is the spark plug wet with gasoline?

- Is the fuel valve opened?
- Choke (close choke lever) and pull the starter handle five or six times. Remove the plug and check if its electrode is wet. If the electrode is wet, fuel is well supplied to your engine.
- When the electrode is dry, check where the fuel stops.
(Check the fuel intake of the carburetor.)
- In case the engine does not start with well supplied fuel, try using fresh fuel.

10. SPECIFICATIONS

MODEL		PKX201	PKX301	PKX401	PKX201ST	PKX301ST
PUMP	Type	Self-priming, Centrifugal pump			Self-priming, Semi Trash pump	
	Suction x Delivery Diameters mm(in.)	50 x 50 (2 x 2)	80 x 80 (3 x 3)	100 x 100 (4 x 4)	50 x 50 (2 x 2)	80 x 80 (3 x 3)
	Total Head m(ft)	30 (98)	31 (102)	27 (89)	30 (98)	28 (92)
	Maximum Delivery Volume Liter(U.S.gal) / min	600 (158)	970 (256)	1350 (356)	580 (153)	930 (246)
	Suction Head m(ft)	8 (26)				
ENGINE	Axle Seal Material (Mechanical Seal)	Ceramic - carbon			Silicon - carbide	
	Model	EX13	EX17	EX27	EX13	EX17
	Type	Air - Cooled, 4 - cycle, OHC, Gasoline Engine				
	Lubricant	Automotive detergent oil (API / SE or higher grade, SG, SH or SJ is recommended, SEA / 10W-30 etc.)				
	Oil Capacity Liter (U.S.gal)	0.6 (0.16)		1.1 (0.29)		0.6 (0.16)
	Fuel	Automotive unleaded gasoline				
	Fuel Tank Capacity Liter (U.S.gal)	2.3 (0.61)	3.2 (0.85)	5.6(1.48)	2.3 (0.61)	3.2 (0.85)
	Spark plug	NGK BR-6HS				
	Starting system	Recoil starter				
Dimensions (L x W x H) mm (in.)	486x357x399 (18.43x14.06x15.71)	505x387x467 (19.88x15.24x18.39)	650x457x645 (25.59x17.99x25.39)	468x357x399 (18.43x14.06x15.71)	505x387x467 (19.88x15.24x18.39)	
Net Weight kg (lb)	24 (52.91)	30 (66.14)	51 (112.44)	25 (55.12)	31 (68.34)	
Standard accessories	Engine tool kit (1set), Strainer (1pc.), Cussion rubber (1set), Hose band (3pcs.)					
Valve Clearance (Intake and Exhaust)	0.12 ^{+0.03} ₀ mm (0.0047 ^{+0.0012} ₀ in.)					
Note : Adjust the valve clearance while the engine is cold.						

MODEL		PKX201T	PKX301T	PKX201H	PKX210	PKX310
PUMP	Type	Self-priming, Trash pump		Self-priming, Centrifugal High Water pump	Self-priming, Centrifugal pump	
	Suction x Delivery Diameters mm(in.)	50 x 50 (2 x 2)	80 x 80 (3 x 3)	50 x 50 (2 x 2)	50 x 50 (2 x 2)	80 x 80 (3 x 3)
	Total Head m(ft)	29 (95)	25 (82)	57 (187)	30 (98)	31 (102)
	Maximum Delivery Volume Liter(U.S.gal) / min	700 (185)	1190 (314)	480 (127)	600 (158)	970 (256)
	Suction Head m(ft)	8 (26)				
ENGINE	Axle Seal Material (Mechanical Seal)	Silicon - carbide			Ceramic - carbon	
	Model	EX17	EX27	EX17	EX16	EX17
	Type	Air - Cooled, 4 - cycle, OHC, Gasoline Engine				
	Lubricant	Automotive detergent oil (API / SE or higher grade, SG, SH or SJ is recommended, SEA / 10W-30 etc.)				
	Oil Capacity Liter (U.S.gal)	0.6 (0.16)	1.1 (0.29)	0.6 (0.16)		
	Fuel	Automotive unleaded gasoline				
	Fuel Tank Capacity Liter (U.S.gal)	3.2 (0.85)	5.6(1.48)	3.2 (0.85)		
	Spark plug	NGK BR-6HS			TORCH E6RC	
	Starting system	Recoil starter				
Dimensions (L x W x H) mm (in.)	620x462x481 (24.1x18.19x18.94)	690x485x537 (27.17x19.09x21.14)	520x390x434 (20.47x15.35x17.09)	505x387x467 (19.88x15.24x18.39)		
Net Weight kg (lb)	48 (105.82)	58 (127.87)	32 (70.55)	27.5 (60.63)	30 (66.14)	
Standard accessories	Engine tool kit (1set), Strainer (1pc.), Cussion rubber (1set), Hose band (3pcs.)					
Valve Clearance (Intake and Exhaust)	0.12 ^{+0.03} ₀ mm (0.0047 ^{+0.0012} ₀ in.)					
Note : Adjust the valve clearance while the engine is cold.						

• Specifications are subject to change without notice

MODEL		PKX401T	PKX220	PKX320	PKX220ST	PKX320ST
PUMP	Type	Self-priming, Trash pump	Self-priming, Centrifugal pump		Self-priming, Semi Trash pump	
	Suction x Delivery Diameters mm(in.)	100 x 100 (4 x 4)	50 x 50 (2 x 2)	80 x 80 (3 x 3)	50 x 50 (2 x 2)	80 x 80 (3 x 3)
	Total Head m(ft)	28 (92)			30 (98)	28 (92)
	Maximum Delivery Volume Liter(U.S.gal) / min	1700 (449)	650 (172)	1100 (291)	580 (153)	930 (246)
	Suction Head m(ft)	8 (26)				
	Axle Seal Material (Mechanical Seal)	Silicon - carbide	Ceramic - carbon		Silicon - carbide	
ENGINE	Model	EX40	EX16	EX17	EX16	EX17
	Type	Air - Cooled, 4 - cycle, OHC, Gasoline Engine				
	Lubricant	Automotive detergent oil (API / SE or higher grade, SG, SH or SJ is recommended, SEA / 10W-30 etc.)				
	Oil Capacity Liter (U.S.gal)	1.2 (0.32)	0.6 (0.16)			
	Fuel	Automotive unleaded gasoline				
	Fuel Tank Capacity Liter (U.S.gal)	6.8 (1.8)	3.2 (0.85)			
	Spark plug	NGK BR-6HS	TORCH E6RC			
	Starting system	Recoil starter				
Dimensions (L x W x H) mm (in.)	745x560x625 (29.33x22.05x24.61)	489x385x410 (19.25x15.16x16.14)	505x387x467 (19.88x15.24x18.39)	489x385x410 (19.25x15.16x16.14)	505x387x467 (19.88x15.24x18.39)	
Net Weight kg (lb)	79 (174.2)	25 (55.12)	30 (66.14)	26 (57.32)	31 (68.34)	
Standard accessories	Engine tool kit (1set), Strainer (1pc.), Hose band (3pcs.)	Engine tool kit (1set), Strainer (1pc.), Cussion rubber (1set), Hose band (3pcs.)				
Valve Clearance (Intake and Exhaust)	0.12 ^{+0.03} mm (0.0047 ^{+0.0012} in.)					
Note : Adjust the valve clearance while the engine is cold.						

• Specifications are subject to change without notice



ISSUE EMD-PU7368



SUBARU

**FUJI HEAVY INDUSTRIES LTD.
INDUSTRIAL PRODUCTS COMPANY**

4-410 ASAHI, KITAMOTO-SHI, SAITAMA, 364-8511, JAPAN
TEL: +81-48-593-7798 FAX: +81-48-593-7946
<http://www.subaru-robin.jp>

PRINTED IN JAPAN
April 2012
