

ULINE H-857, H-1296, H-5130
H-7958, H-9483
MILLER® HARNESSSES

1-800-295-5510
uline.com

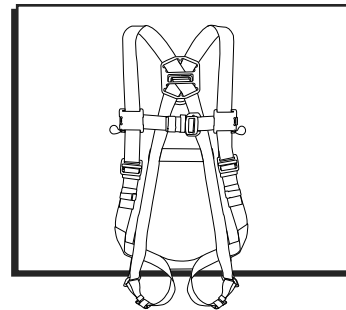

INSTRUCTIONS

HOW TO DON A HARNESS

1. Holding harness by back D-ring, ensure straps are unbuckled and untwisted. (See Figure 1)
2. Slip straps over shoulders so back D-ring is located between shoulder blades. (See Figure 2)
3. Pull leg straps between legs and buckle to corresponding ends. Tighten leg straps until snug. (See Figure 3)

 **NOTE:** Leg straps should not be too snug as to obstruct blood circulation in legs.

4. Buckle chest strap so that it is positioned in mid-chest area. If adjustable, tighten until snug. (See Figure 4)

 **NOTE:** Chest strap should be 6-8" below the trachea, but not below the sternum.

5. After buckling all straps, readjust harness fit as needed. Secure excess strap in elastic loop keepers.

HARNESS CARE

When not in use, hang harness by back D-ring in order to maintain shape.

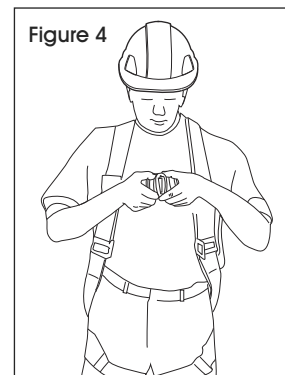
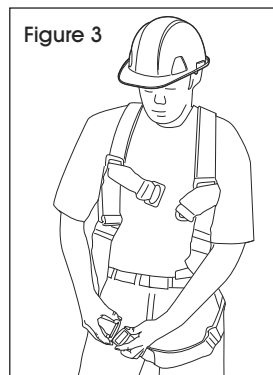
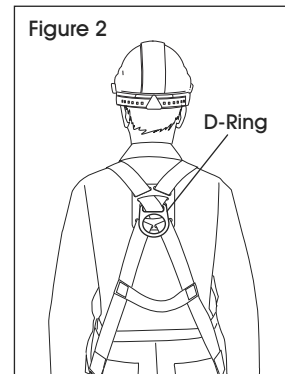
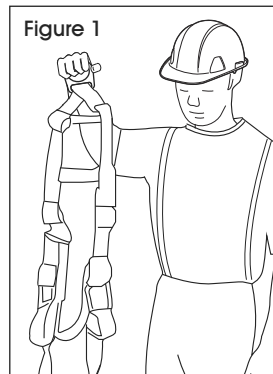

SIZING CHART

 **NOTE:** This chart serves only as a guideline for harness sizing.

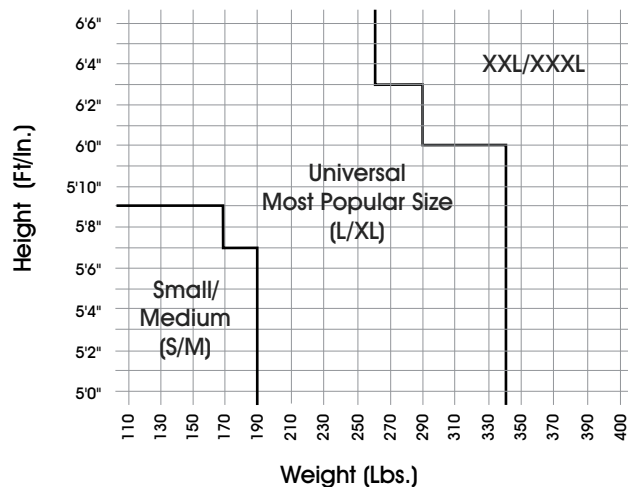



H-857, H-1296, H-5130
H-7958, H-9483

800-295-5510
uline.mx

MILLER® ARNESES

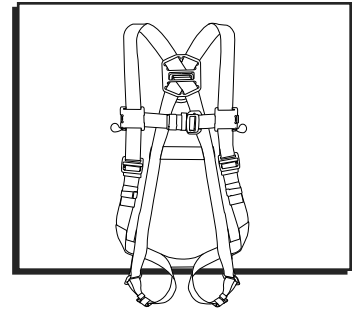

INSTRUCCIONES

CÓMO PONERSE UN ARNÉS

1. Sostenga el arnés del anillo en D posterior, asegúrese de que las correas estén desabrochadas y desenrolladas. (Vea Diagrama 1)
2. Deslice las correas sobre los hombros para que el anillo en D se coloque entre los omóplatos. (Vea Diagrama 2)
3. Jale las correas para las piernas entre las mismas y el broche hacia los extremos correspondientes. Apriete las correas de las piernas hasta que estén ceñidas. (Vea Diagrama 3)



NOTA: Las correas para las piernas no deben estar demasiado apretadas ya que pueden obstruir la circulación de la sangre.

4. Abroche la correa para el pecho de modo que quede posicionada a la mitad del mismo. Si es ajustable, apriete hasta que esté ceñido. (Vea Diagrama 4)



NOTA: La correa para el pecho debe estar a 15-20 cm (6-8") por debajo de la tráquea, pero no por debajo del esternón.

5. Después de abrochar todas las correas, reajuste el arnés como sea necesario. Asegure el exceso de las correas en los lazos elásticos.

CUIDADO DEL ARNÉS

Cuando no esté en uso, cuelgue el arnés por la parte del anillo en D posterior para mantener la forma.



TABLA DE TALLAS



NOTA: Esta tabla sirve solamente como guía para conocer las tallas de los arneses.



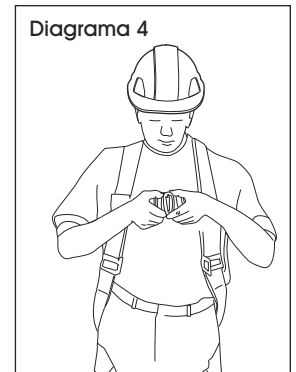
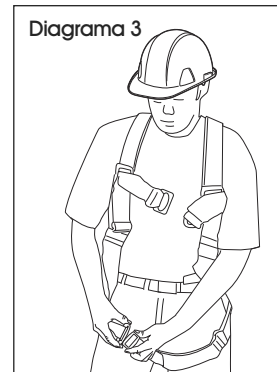
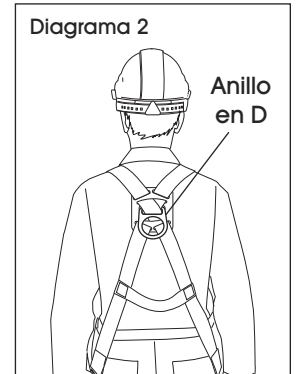
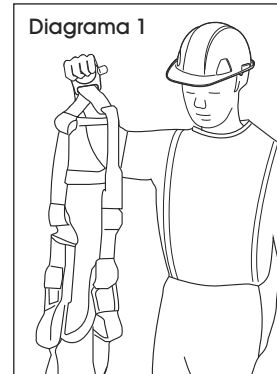
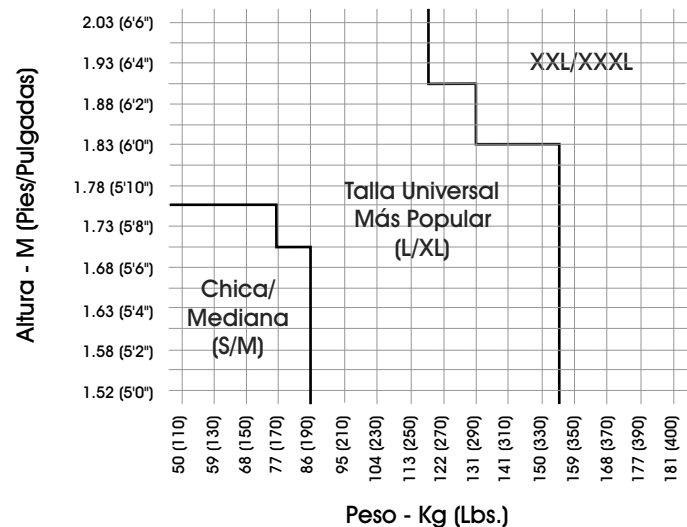

H-857, H-1296, H-5130
H-7958, H-9483

MILLER^{MD} – HARNAIS

1-800-295-5510
uline.ca

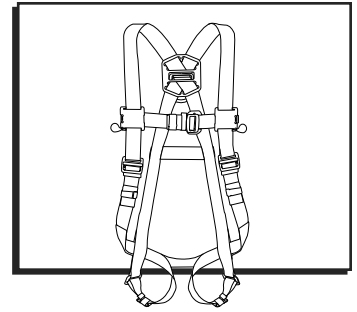

INSTRUCTIONS

COMMENT ENFILER UN HARNAIS

1. Tenez l'anneau en D situé au dos du harnais et vérifiez que les sangles ne sont pas bouclées ni enroulées. (Voir Figure 1)
2. Passez les sangles par-dessus les épaules de sorte que l'anneau en D se trouve entre les omoplates. (Voir Figure 2)
3. Tirez les sangles des jambes entre les jambes et attachez-les aux extrémités correspondantes. Serrez les sangles des jambes jusqu'à ce qu'elles soient bien ajustées. (Voir Figure 3)

 **REMARQUE :** Les sangles des jambes ne devraient pas être trop serrées, car cela pourrait entraver la circulation du sang dans les jambes.

4. Bouclez la sangle de poitrine afin qu'elle soit positionnée au milieu de la poitrine. Si réglable, serrez jusqu'à ce qu'elle soit bien ajustée. (Voir Figure 4)

 **REMARQUE :** La sangle de poitrine doit être située à 15-20 cm (6 à 8 po) au-dessous de la trachée, mais non plus bas que le sternum.

5. Réajustez le harnais au besoin après avoir bouclé toutes les sangles. Sécurisez l'excès de sangle dans les anneaux de support élastiques.

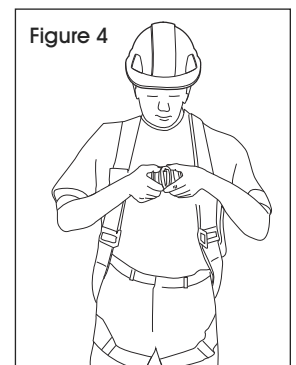
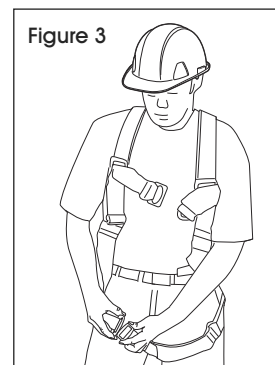
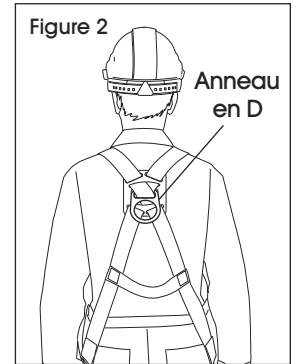
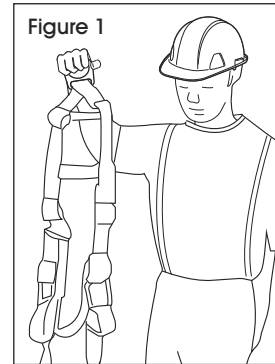

ENTRETIEN DU HARNAIS

Lorsque le harnais n'est pas utilisé, suspendez-le par l'anneau en D pour garder sa forme.

TABLEAU DE TAILLE

 **REMARQUE :** Ce tableau ne sert uniquement que de guide pour les tailles de harnais.

